



**INSTRUCTION MANUAL**  
**MT933**  
**CABLE LENGTH TESTER**





# Contents

Page no

1. Description.....	4
2. Safety Instructions.....	4
3. General Description.....	4
4. Meter Description.....	5
4.1. Instrument Description.....	5
4.2. Symbols and Annunciators.....	6
4.3. Accessories Provided.....	6
5. Description of Function Keys.....	6
5.1. Backlight Button.....	6
5.2. Hold Button.....	6
5.3. MEM Button.....	7
5.4. CAL Button.....	7
5.5. FT/M Button.....	7
5.6. Cu/AI Button.....	7
5.7. Up/Down Button.....	7
6. Operating.....	8
6.1. Calibration Procedure.....	8
6.2. Measuring Length of Wire.....	9
6.3. User Select Mode.....	11
6.4. How to save the resistance of a user wire.....	11
6.5. Measure the length of cable in user-defined mode.....	12
6.6. Clear memory locations in user select mode.....	13
6.7. Measuring Resistance.....	13
6.8. Measuring Temperature.....	13
7. Maintenance.....	14
8. Battery Installation.....	14
9. Specifications.....	15
9.1. Technical Specifications.....	15
9.2. General Specifications.....	15

## 1. DESCRIPTION

- The Cable Length Meter is a hand-held testing device with the following measurement capabilities: resistance, temperature and length.
- They can be used as  $m\Omega$  meters to measure precise bonding resistances.
- The primary function of these meters is to calculate the length of cable based upon its material, temperature, and cable gauge, Cable material type can be either uncoated copper or aluminum.
- There are 20 pre-programmed and eight programmable cable gauges. (There are no strands per cable specification for the eight programmable switch positions.)

## 2. SAFETY INSTRUCTIONS



**WARNING:** observe the instructions given in this manual; improper use could damage the instrument or its components.



Double-insulated meter

- Do not connect this unit to live voltage.
- Do not expose this unit to rain or moisture.
- Do not use the unit if it is wet or damaged.
- Do not operate with the case open.
- Do not attempt to repair this unit. it contains no user serviceable parts.
- Do not expose the unit to extremes in temperature or high humidity, Refer to "Specifications."
- Before opening the case, remove the test leads from the circuit and shut off the unit.
- Using this unit near equipment that generates electromagnetic interference can result in unstable or inaccurate readings.
- Inspect the test leads or accessory before use, they must be clean and dry, and the insulation must be in good condition.
- Use this unit for the manufacturer's intended purpose only, as described in this manual, any other use can impair the protection provided by the unit.
- Failure to observe these warnings could result in severe injury or death.

## 3. GENERAL DESCRIPTION

The instrument carries out the following measurements:

1. Twenty measurement gears in line with industry standards: 0.15, 0.25, 0.5, 0.75, 1, 1.5, 2.5, 4, 6, 10, 25, 35, 50, 70, 95, 120, 150, 185, 240mm<sup>2</sup>.

2. Eight memory locations in user select mode.
3. m $\Omega$  resistance test mode.
4. Measures copper and aluminum cables.
5. Ambient temperature testing provides automatic compensation for measurements.

#### 4. METER DESCRIPTION

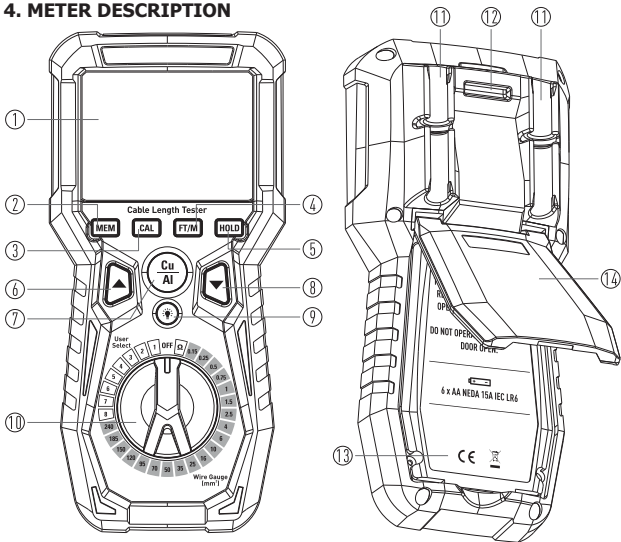

##### 4.1. Instrument Description

- |                             |                    |                           |
|-----------------------------|--------------------|---------------------------|
| 1 - LCD Display             | 12 - Lanyard Hole  | 15 - Black Input Terminal |
| 2 - MEM Button              | 13 - Battery Cover | 16 - Red Input Terminal   |
| 3 - CAL Button              | 14 - Tilt Stand    | 17 - NTC                  |
| 4 - FT/M Button             |                    |                           |
| 5 - HOLD Button             |                    |                           |
| 6 - UP Button               |                    |                           |
| 7 - Cu/ Al Button           |                    |                           |
| 8 - DOWN Button             |                    |                           |
| 9 - Backlight Button        |                    |                           |
| 10 - Rotary Selector Switch |                    |                           |
| 11 - Test Lead Holders      |                    |                           |

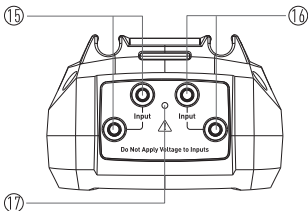

## 4.2. Symbols and Annunciators

- |   |                               |
|---|-------------------------------|
| 1 - Used to save data or for confirmation | 10 - In user select mode      |
| 2 - Temperature                           | 11 - kilo meter foot          |
| 3 - Celsius and Fahrenheit units          | 12 - Data Hold                |
| 4 - Low Resistance                        | 13 - ERROR                    |
| 5 - Copper                                | 14 - Auto Power Off           |
| 6 - Aluminum                              | 15 - Low battery              |
| 7 - Calibrate                             | 16 - Negative reading display |
| 8 - Measurement display digits            | 17 - NTC                      |
| 9 - milliohms (Resistance)                |                               |

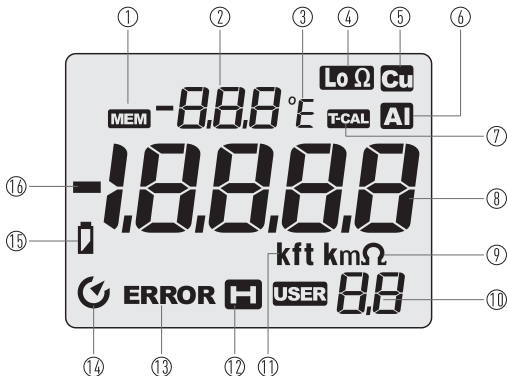

## 4.3. Accessories Provided

- Carrying Bag
- User Manual
- Copper Rod
- Kelvin Clips x 2

## 5. DESCRIPTION OF FUNCTION KEYS

### 5.1. Backlight Button

- Press the **Backlight** Button to turn on the backlight.
- Press the **Backlight** Button again to turn off the backlight.

### 5.2. HOLD Button

- Press the **HOLD** Button, the present reading on the bottom line of the display will be held on the display.
- To exit Data Hold mode, press the **HOLD** Button again.

### 5.3. MEM Button

- The **MEM** Button is used for the user-selected programming function.
- Refer to "**Operation**" for a complete description of the programming process.
- Press and hold the **MEM** Button to cancel the auto-shutdown function.

### 5.4. CAL Button

- The meter must be calibrated each time it is turned ON.
- Refer to "Operation" for a complete description of the calibration process.
- Used to enter/exit sample wire length setting mode.

### 5.5. FT/M Button

- Press momentarily to select length measurement units.
- On the LCD, "ff indicates feet and "m" indicates meters.

### 5.6. Cu/Al Button

- Press the Cu/Al Button to select copper or aluminum wire measurement.
- Press and hold the Cu/Al Button to select °C/°F.

### 5.7. Up/Down Button

- Used during the user-selected programming process.
- Refer to "Operation" for a complete description of the programming process.

## 6. OPERATING

**WARNING:** Do not connect the unit to live voltage.

### 6.1. Calibration Procedure

1. Each time the meter is turned ON, it should be calibrated before use.
2. Set the rotary switch from the OFF to O Position.
3. Connect the two leads for the red set of Kelvin clips are plugged into the red terminals on the meter; Connect the two leads for the black set of Kelvin clips are plugged into the black terminals on the meter.

**Note:** Make sure the calibration bar and Kelvin clips jaws are clean.

4. Connect the two alligator clips to the supplied copper rod, move the clips as close together as possible.

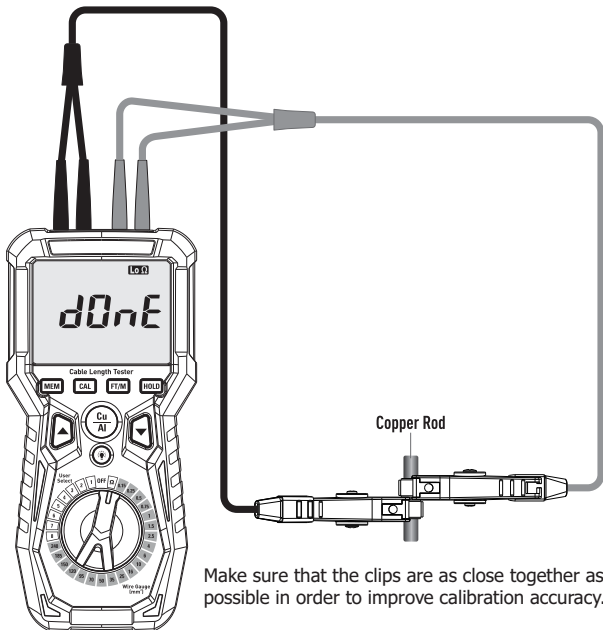

Make sure that the clips are as close together as possible in order to improve calibration accuracy.



5. Press the **CAL** Button, the display alternately shows " **YES** " and " **no** "; flash twice each time. Press the **MEM** Button, if the display briefly shows " **dOnE** " and then the meter returns to resistance measurement mode, the calibration succeeds.

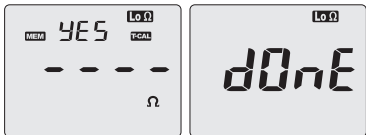

6. If the display shows " **FAI L** " after you press the **MEM** Button, the calibration fails and you need to check whether the connections and contacts are correct and good. If you press the **CAL** Button again, the meter will cancel calibrating and return to resistance measurement mode.



## 6.2. Measuring Length of Wire

**WARNING:** Do not connect this unit to live voltage.

1. Set the rotary switch from the OFF to  $\Omega$  Position.
  2. Calibrate the meter as described in "Calibration Procedure".
  3. For best results, allow the meter and the wire to be measured to attain the same ambient temperature. Typically, it will take about 30 minutes.
  4. Strip the insulation back on each end of the wire to be measured.
- Note:** make sure both ends of the wire are clean and the conductor is fully exposed. Use abrasive paper to remove oxide layer on each end if necessary.
5. Set the rotary switch from the OFF to Wire Gauge Position according to the wire gauge of the wire to be measured; for example If the wire gauge of the wire is 1 mm<sup>2</sup>, you must set the rotary switch in the "1" Position.
  6. If the wire to be measured is a copper wire, press the Cu/Al Button until "Cu" appear on the display: If the wire is an aluminum wire, press the Cu/Al Button until "Al" appears on the display.
  7. Press the FT/M Button to select desired unit.
  8. Connect an alligator clip to one end of the wire to be measured and the other alligator clip to the other end of this wire.

9 . The display shows the length of the wire.

10. When the measurements finishes, remove the alligator clips from the wire.

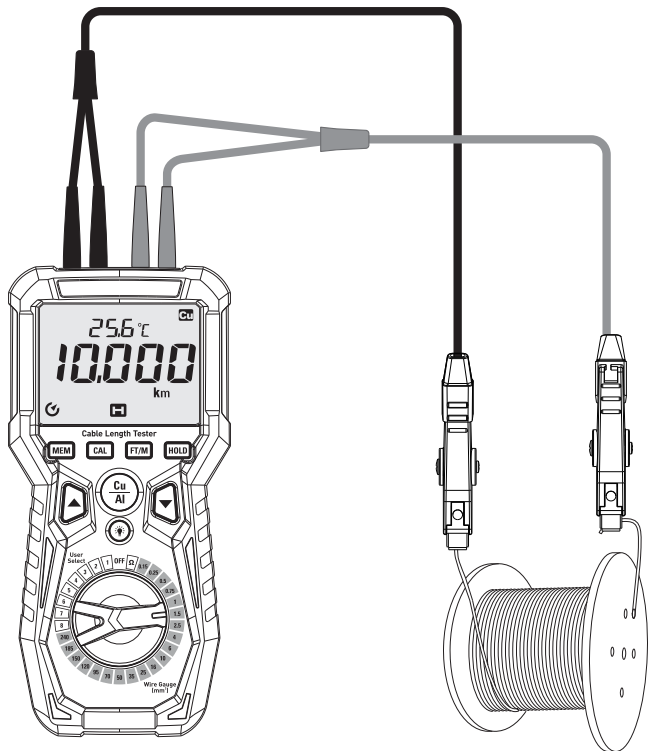

Typical Configuration

### 6.3. User Select Mode

- The use select mode allows user to save the resistance parameter of a user wire for length measurements of the wires of the same kind (Same gauge and same conductor material).
- In addition, it enables user to accurately measure the length of standard gauge wires.
- In this mode, user can measure the length of any metal wires (including copper or aluminum wires).

**Note:** The sample length of user wires must be between 4m and 100m in METER mode or between 13.1ft and 320ft in FEET mode.

### 6.4. How to save the resistance of a user wire

**Note:** Prepare a 4-100m (or 13.1ft-320ft in FEET MODE) Sample length of the wire to be programmed into the meter so that the meter can correctly measure the resistance of this sample wire and store it in lengths of the same kind wire when you want. Make sure the sample wire to be measured is not energized or live.

1. Set the rotary switch from the **OFF** to  $\Omega$  Position.
2. Calibrate the meter as described in "**Calibration Procedure**".
3. For best results, allow the meter and the sample wire to be measured to attain the same ambient temperature.
4. Remove the insulation at both ends of the cable under test.

**Note:** Make sure that the two conductors of the cable under test are clean and fully exposed, and that the insulation must be removed to make it easier for the test rod to fully clamp the cable. If desired, use an abrasive paper to clean the exposed wire head.

5. The rotary knob selects the user-defined mode gear, and there are 1 to 8 (8) user-defined mode gears on the meter, the selected gear is displayed in the upper left corner of the screen.
6. For example, when the user selects the knob, " **USER 3** " will be displayed on the screen if the selected gear already has a cable parameter, the screen will display "OL".

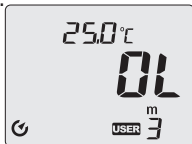

7. Press the **FT/M** Buttons to select feet or meters.
8. Press the **CAL** Button, The meter enters sample wire length setting mode; in this mode, the display alternately show " **MEM YES** " and " **NO MEM** " among them "**MEM**" and "**TCAL**" flash twice each time.

9. Press the upper end of the **Up/Down** Button to increase or the lower end of this button to decrease the reading on the display in 0.1 increments or decrements, adjust the reading until it equals the length of the sample wire to be measured.
10. Connect an alligator clip to one end of the sample wire and the other alligator clip to the other end of this wire.
11. Press the **MEM** Button once, if the display shows "dOnE" briefly and then the meter returns to measurement mode, the setting was accepted.



**Note:** If the display shows "FAl L", and "ERROR", the setting fails and you should check whether the connections and contacts are correct and good. Press the **CAL** Button again, the meter will return to measurement mode.

12. When the setting finishes, remove the two alligator clips from the sample wire.

### 6.5. Measure the length of the cable in user-defined mode

1. Set the rotary switch from the OFF to  $\Omega$  Position.
2. Calibrate the meter as described in "**Calibration Procedure**".
3. For best results, allow the meter and the sample wire to be measured to attain the same ambient temperature.
4. Remove the insulation at both ends of the cable under test.

**Note:** Make sure that the two conductors of the cable under test are clean and fully exposed, and that the insulation must be removed to make it easier for the test rod to fully clamp the cable. If desired, use abrasive paper to clean the exposed wire head.

4. With the knob, select the appropriate user-defined gear measurement.
5. Press the **FT/M** Button to select feet or meters.
6. Connect the Kelvin Clips to the metal ends of the cable under test.
7. The cable length is read directly from the screen.
8. When the measurement is complete, disconnect the Kelvin Clips.

## 6.6. Clear memory locations in user select mode

1. Disconnect the Kelvin Clips from the cable under test.
2. The knob selects the user-custom gear that needs to be cleared.
3. Press **CAL** Button to display "MEM 9E5". Press the **MEM** Button again, the meter will erase the stored data in the selected memory location and the meter will return to measurement mode and the selected memory location is empty.
4. The symbol "MEM CLR" means that pressing the **MEM** Button will erase the stored data in the selected memory location, the symbol "OUT CAL" means that pressing the **CAL** Button will cause the meter to return to measurement mode.

## 6.7. Measuring Resistance

1. Set the rotary switch from the OFF to  $\Omega$  Position.
2. Calibrate the meter as described in "**Calibration Procedure**".
3. For best results, allow the meter and the sample wire to be measured to attain the same ambient temperature.
4. Remove the insulation at both ends of the cable under test.

**Note:** Make sure that the two conductors of the cable under test are clean and fully exposed, and that the insulation must be removed to make it easier for the Kelvin Clips to fully clamp the cable. If desired, use abrasive paper to clean the exposed wire head.

5. Connect the two leads for the red set of Kelvin clips are plugged into the red terminals on the meter; Connect the two leads for the black set of Kelvin clips are plugged into the black terminals on the meter.
6. The screen shows the impedance value read directly.

## 6.8. Measuring Temperature

1. The temperature reading shown on the display.
2. When the temperature is lower the  $-5^{\circ}\text{C}$  or  $23^{\circ}\text{F}$ , the display will show "-OL".
3. When the temperature is higher the  $50^{\circ}\text{C}$  or  $122^{\circ}\text{F}$ , the display will show "OL".
4. Press and hold **Cu/Al** Button to select  $^{\circ}\text{C}/^{\circ}\text{F}$ .

## 7. MAINTENANCE

**WARNING:** Before opening the case, remove the test leads from the circuit and shut off the unit. This Meter is designed to provide years of dependable service, if the instructions below are followed:

- Keep the meter dry. If it gets wet, wipe it off.
- Use and store the meter in normal temperatures, temperature extremes can shorten the life of the electronic parts and distort or melt plastic parts.
- Handle the meter gently and carefully, dropping it can damage the electronic parts or the case.
- Keep the meter clean, wipe the case occasionally with a damp cloth, do not use chemicals, cleaning solvents or detergents.
- Use only fresh batteries of the recommended size and type, remove old or weak batteries so they do not leak and damage the unit.
- If the meter is to be stored for a long period of time, the batteries should be removed to prevent damage to the unit.

## 8. BATTERY INSTALLATION

**WARNING:** To avoid electric shock, disconnect the test leads from any source of voltage before removing the battery cover.

- Keep the meter dry, if it gets wet. wipe it off.
- Use and store the meter in normal temperatures, temperature extremes can shorten the life of the electronic parts and distort or melt plastic parts.
- Handle the meter gently and carefully, dropping it can damage the electronic parts or the case.
- Keep the meter clean, wipe the case occasionally with a damp cloth, do not use chemicals, cleaning solvents or detergents.
- Use only fresh batteries of the recommended size and type, remove old or weak batteries so they do not leak and damage the unit.
- If the meter is to be stored for a long period of time, the batteries should be removed to prevent damage to the unit.

## 9. SPECIFICATIONS

### 9.1. Technical Specifications

Function	Range	Resolution	Accuracy	Protection against overcharge
Length Measurement Range	1 000m	0.1m	$\pm(1\% \text{ reading}+1\text{ml})$	Max 60V Overload Protection
	10 000m	1m	$\pm(1\% \text{ reading}+1\text{ml})$	
	30km	0.01km	$\pm(1.2\% \text{ reading}+1\text{ml})$	
	1 000ft	0.1ft	$\pm(1\% \text{ reading}+3\text{ft})$	
	10 000ft	1ft	$\pm(1\% \text{ reading}+1\text{ft})$	
	100kft	0.01ft	$\pm(1.2\% \text{ reading}+1\text{ft})$	
Resistance Measurement Range	1999.9m $\Omega$	0 0.1m $\Omega$	$\pm(1.0\% \text{ reading}+3 \text{ digits})$	Max 60V Overload Protection
	19.999 $\Omega$	0.001 $\Omega$	$\pm(1.0\% \text{ reading}+0.5\text{m}\Omega)$	
	199.99 $\Omega$	0.01 $\Omega$	$\pm(1.0\% \text{ reading}+50\text{m}\Omega)$	
	1999.9 $\Omega$	0.1 $\Omega$	$\pm(1.0\% \text{ reading}+6 \text{ digits})$	
Temperature Measurement	-5 to 50°C	0.1°C	$\pm(2.0\%+1.8^\circ\text{C})$	
	23 to 122°F	0.1°F	$\pm(2.0\%+3.5^\circ\text{C})$	

### 9.2. General Specifications

Function	Range
Display	(19999 counts) LCD display
Low Battery Indication	" $\text{⏻}$ " is displayed
Overrange Indication	"OL" display
Operating Temperature	0 to 40°C (32 to 104°F)
Storage Temperature	-20 to 60°C (-4 to 140°F)
Operating Humidity	Max 80% up to 31°C (87°F) decreasing linearly to 50% at 40°C (104°F)
Storage Humidity	<80%
Operating Altitude	2000 meters (7000ft.) maximum.
Drop Protection	1m (3.3ft)
Battery	6 x 1.5V AA Batteries
Low Battery Indicator	Approximately 7.2V
Battery Life	Capacity - 900mAh
Auto Power Off	After approx. 15 minutes
Dimensions	210 x 97 x 68mm
Weight	634g



---

***MAJOR TECH (PTY) LTD***

**South Africa**

 [www.major-tech.com](http://www.major-tech.com)

 [sales@major-tech.com](mailto:sales@major-tech.com)

**Australia**

 [www.majortech.com.au](http://www.majortech.com.au)

 [info@majortech.com.au](mailto:info@majortech.com.au)

